

BaleTainer NP 22 HS SW 1R RA SG

BaleTainer NP 22 HS SW 1R RA SG

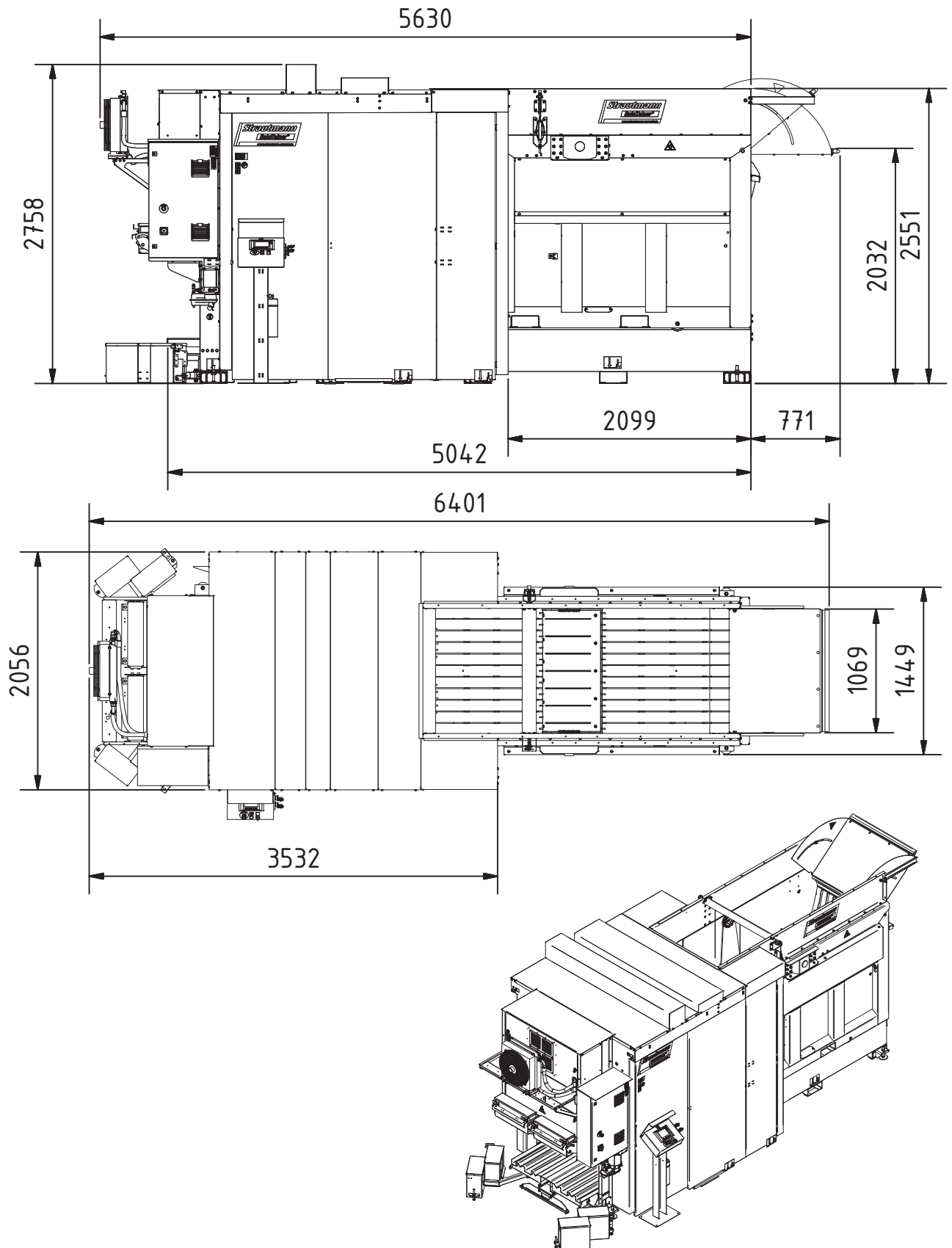

Ausführung Schwingenschacht, Rampenbefüllung, Einfachrotor
construction swing arm, feeding at the ramp, 1 rotor

Alle Abmessungen in mm
All dimensions in mm

V4130001

Stand: B

1 / 4

BaleTainer NP 22 HS SW 1R RA SG

BaleTainer NP 22 HS SW 1R RA SG

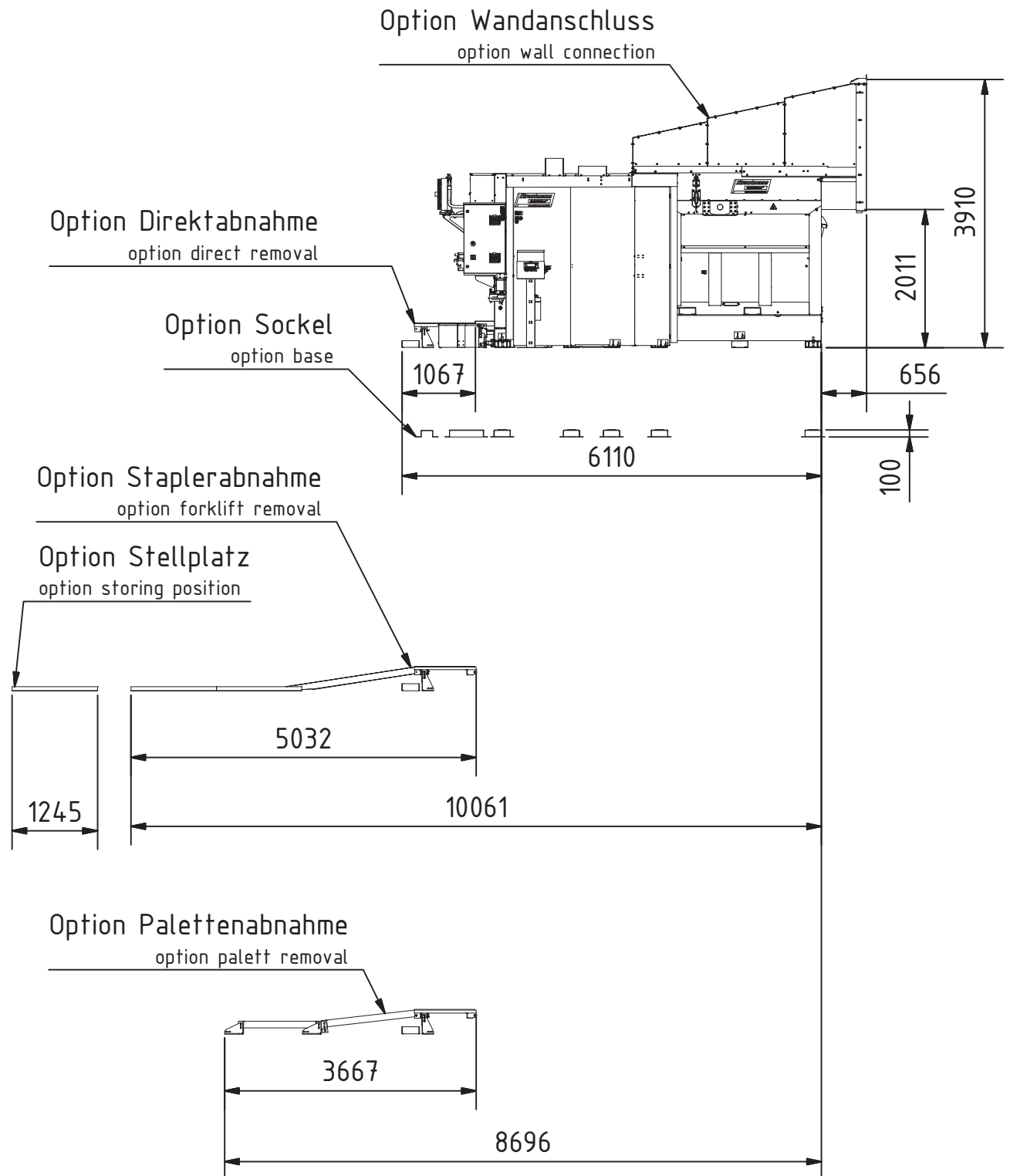

additive Optionen
additive options

Alle Abmessungen in mm
All dimensions in mm

V4130001

Stand: B

2 / 4

BaleTainer NP 22 HS SW 1R RA SG

BaleTainer NP 22 HS SW 1R RA SG

Packstück 1

Presseinheit

package 1
pressing unit

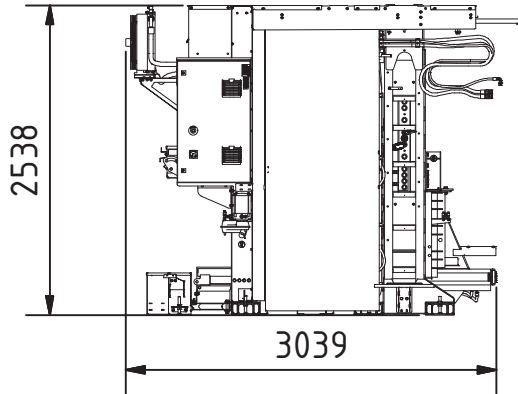

Packstück 2

Zuführeinheit

package 2
feeding unit

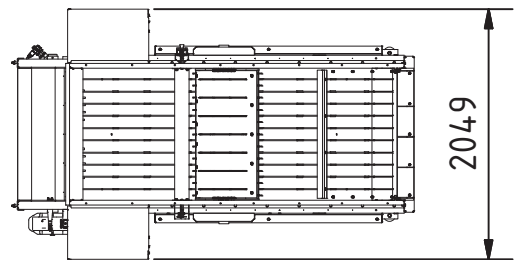
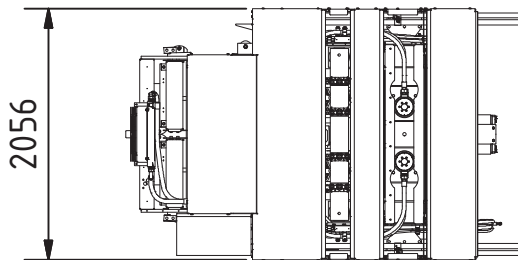
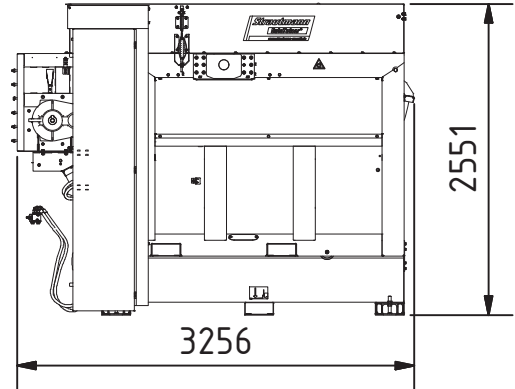

Packstück 3

Option Palettenabnahme

package 3
option palett removal

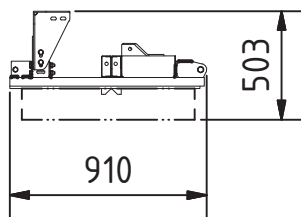

Packstück 3

Option Staplerabnahme

package 3
option forklift removal

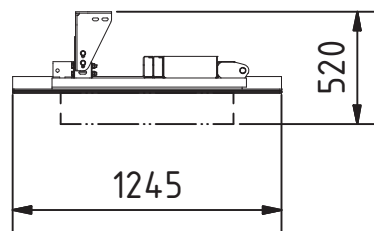

Packstück 3

Option Direktabnahme

package 3
option direct removal

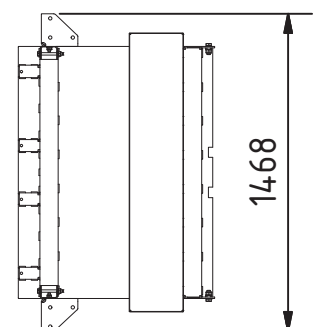
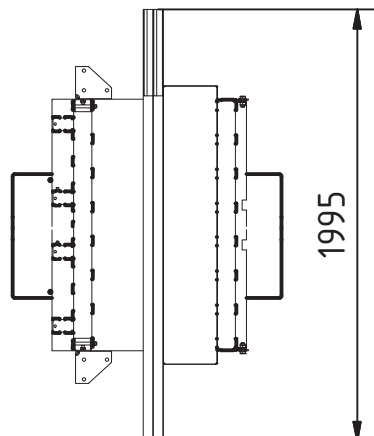
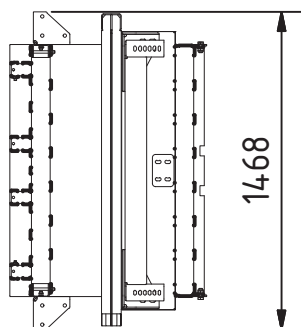
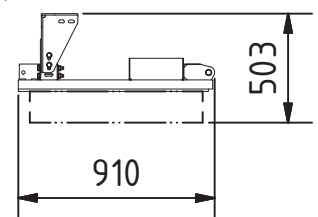

Transportabmessungen
transport dimensions

Alle Abmessungen in mm
All dimensions in mm

Maß- und Konstruktionsänderungen behalten wir uns vor.
We reserve the right to make dimensional and design changes.

BaleTainer NP 22 HS SW 1R RA SG

BaleTainer NP 22 HS SW 1R RA SG

Packstück 4
Option Socket
package 4
option base

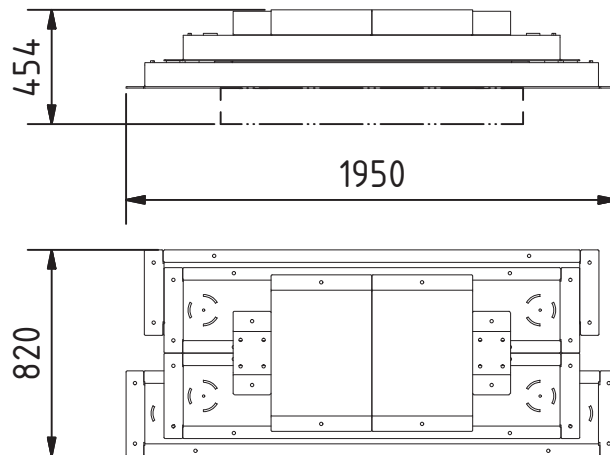

Packstück 5
Option Wandanschluss
package 5
option wall connection

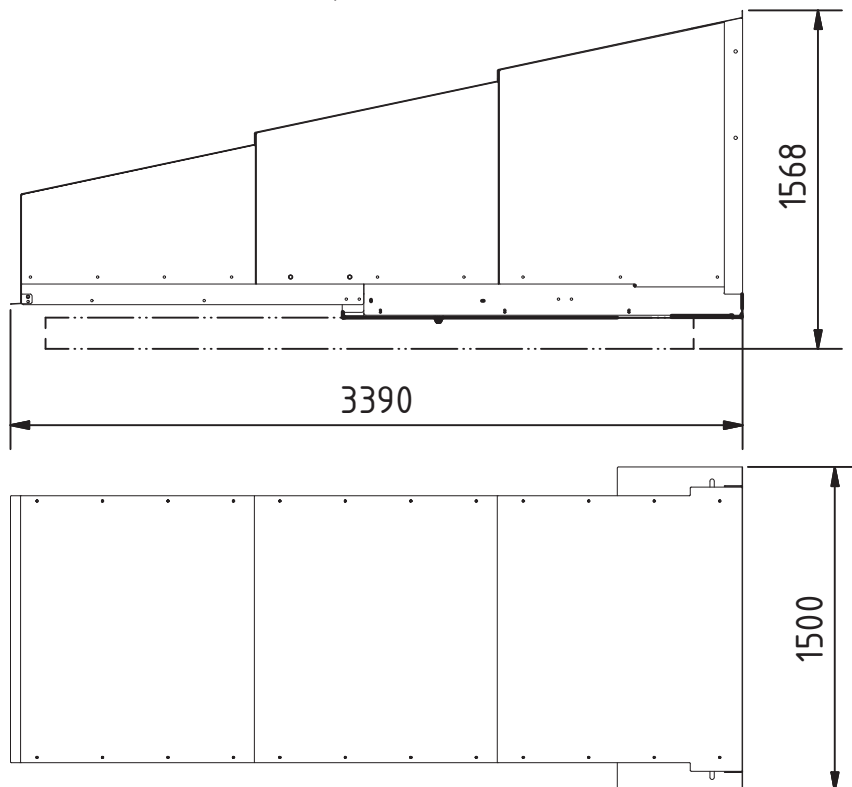

Transportabmessungen
transport dimensions

Alle Abmessungen in mm
All dimensions in mm

Datenblatt / Data sheet

BaleTainer NP 22 HS SW 1R RA SG

BaleTainer NP 22 HS SW 1R RA SG

Bestellnummer: Order number:	V4130001										
Elektroanschluss: Power supply:	400 V, 50 Hz, 3PH + N + PE 63 A Kategorie C										
Elektrische Leistung: Electrical Power:	27,5 kW										
Schutzart: Protection class:	IP54										
Presskraft: Pressing force:	600 kN										
Presshub: Press stroke:	750 mm										
Maschinengewicht ca.: Weight of the machine approx.:	7350 kg										
Transportabmessungen ca. (bxtxh): Transport dimensions approx. (wxdxh):	<table border="0"> <tr> <td>Packstück 1 / Package 1</td> <td>3039 x 2056 x 2538 mm</td> </tr> <tr> <td>Packstück 2 / Package 2</td> <td>3256 x 2049 x 2551 mm</td> </tr> <tr> <td>Packstück 3 / Package 3</td> <td>max. 1995 x 1245 x 520 mm</td> </tr> <tr> <td>Packstück 4 / Package 4</td> <td>1950 x 820 x 454 mm</td> </tr> <tr> <td>Packstück 5 / Package 5</td> <td>3390 x 1500 x 1568 mm</td> </tr> </table>	Packstück 1 / Package 1	3039 x 2056 x 2538 mm	Packstück 2 / Package 2	3256 x 2049 x 2551 mm	Packstück 3 / Package 3	max. 1995 x 1245 x 520 mm	Packstück 4 / Package 4	1950 x 820 x 454 mm	Packstück 5 / Package 5	3390 x 1500 x 1568 mm
Packstück 1 / Package 1	3039 x 2056 x 2538 mm										
Packstück 2 / Package 2	3256 x 2049 x 2551 mm										
Packstück 3 / Package 3	max. 1995 x 1245 x 520 mm										
Packstück 4 / Package 4	1950 x 820 x 454 mm										
Packstück 5 / Package 5	3390 x 1500 x 1568 mm										
Transportgewichte ca.: Transport weights approx.:	<table border="0"> <tr> <td>Packstück 1 / Package 1</td> <td>5000 kg</td> </tr> <tr> <td>Packstück 2 / Package 2</td> <td>2350 kg</td> </tr> <tr> <td>Packstück 3 / Package 3</td> <td>205 / 160 / 60 kg</td> </tr> <tr> <td>Packstück 4 / Package 4</td> <td>165 kg</td> </tr> <tr> <td>Packstück 5 / Package 5</td> <td>260 kg</td> </tr> </table>	Packstück 1 / Package 1	5000 kg	Packstück 2 / Package 2	2350 kg	Packstück 3 / Package 3	205 / 160 / 60 kg	Packstück 4 / Package 4	165 kg	Packstück 5 / Package 5	260 kg
Packstück 1 / Package 1	5000 kg										
Packstück 2 / Package 2	2350 kg										
Packstück 3 / Package 3	205 / 160 / 60 kg										
Packstück 4 / Package 4	165 kg										
Packstück 5 / Package 5	260 kg										
Einfüllöffnung ca. (b): Filling opening approx. (w):	1069 mm										
Taktzeit: Cycle Time:	-										
Ballengewicht: Bale weight :	max. 400 kg*										
Ballenabmessungen in der Kammer (bxtxh): Bale size in the chamber (wxdxh):	1100 x 1100 x 800 mm*										
Ballenabbindung: Bale tying:	Umreifung mit vier Drähten strapping with four wires										
Bemerkung: Comment:	-										

* Die Ballenmaße und –Gewichte sind circa maß- und materialabhängig. Die Angaben beziehen sich auf Kartonage (Qualität 1.04). Informationen zu anderen Materialien bitte auf Anfrage.

The bale size and bale weights are approximate dimension and depending on the material. The information refers to cardboard packaging (quality 1.04). Information about other materials on request.

**Die Ballengewichte beziehen sich auf Testresultate unter idealen Bedingungen mit idealem Material.
The bale weights are based on test results under ideal conditions by using ideal material.

Maß- und Konstruktionsänderungen behalten wir uns vor.
We reserve the right to make dimensional and design changes.